





9IS2473700

RTX 600 /VS DOMINO ZERO

www.eliwell.com

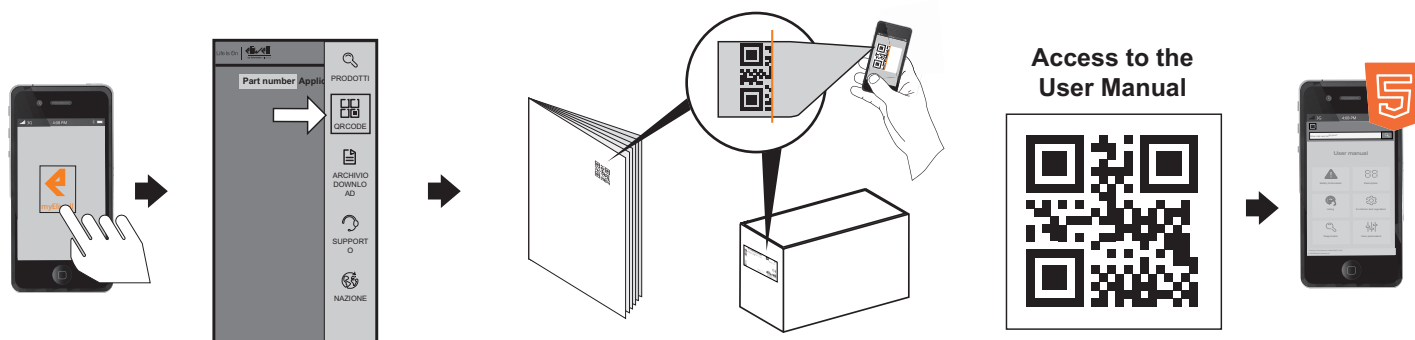
For further information regarding the product, scan the QR code using the myEliwell app to access the user manual



If the "myEliwell" app () has not been yet downloaded, you can do it from:



or



ELECTRICAL CONNECTIONS

DANGER

HAZARD OF ELECTRIC SHOCK, EXPLOSION OR ARC FLASH

- Disconnect all power from all devices including connected devices, prior to removing any covers or doors, or installing or removing any accessories, hardware, cables, or wires except under the specific conditions specified in the user manual.
- Always use a properly rated voltage sensing device to confirm the power is off where and when indicated.
- Replace and secure all covers, accessories, hardware, cables and wires.
- Verify the earthing connections on all earthed devices.
- Use this equipment and all connected products only at the specified voltage.
- Do not connect the device directly to the line voltage, except where indicated otherwise.

Failure to follow these instructions will result in death or serious injury.

DANGER

HAZARD OF OVERHEATING AND FIRE

- Do not use with loads other than those indicated in the technical data.
- Do not exceed the maximum permitted current; in the case of higher loads, use a contactor with suitable power.

Failure to follow these instructions will result in death or serious injury.

WARNING

UNINTENDED EQUIPMENT OPERATION

- Use shielded cables for all analog I/O and communication signals.
- Ground the cable shields for all communication signals at a single point.
- Signal leads (probes, digital inputs, communication, and the electronic supply) must be routed separately from power cables.
- Reduce the length of the wires and cables as much as possible and avoid winding them around electrically connected parts.

Failure to follow these instructions can result in death, serious injury, or equipment damage.

The temperature (NTC/PTC/Pt1000) probes have no specified connection polarity; the connections can be extended using a normal bipolar cable. The extension of the probes wiring influences the electromagnetic compatibility (EMC) of the device.

Ratiometric (0...5 V) and **pressure** (4...20 mA) **transducers**, have a connection polarity.

Electrical equipment must only be installed, used and repaired by qualified technicians. Schneider Electric and Eliwell cannot accept any liability for any consequences arising from the use of this material.

FLAMMABLE REFRIGERANT GASES

This equipment is designed to operate in non-hazardous areas and where applications which generate - or could potentially generate - hazardous atmospheres have been isolated. Install this equipment only in areas and with applications known to be constantly free from hazardous atmospheres.

⚠ DANGER

HAZARD OF EXPLOSION

- Install and use this equipment in non-hazardous locations only.
- Do not install or use this equipment in applications which could generate hazardous atmospheres, such as those using flammable refrigerants.

Failure to follow these instructions will result in death or serious injury.

For information regarding the use of control equipment in applications capable of generating hazardous materials, please contact the regulatory office or the local, regional or national certification authority.

DIMENSIONS

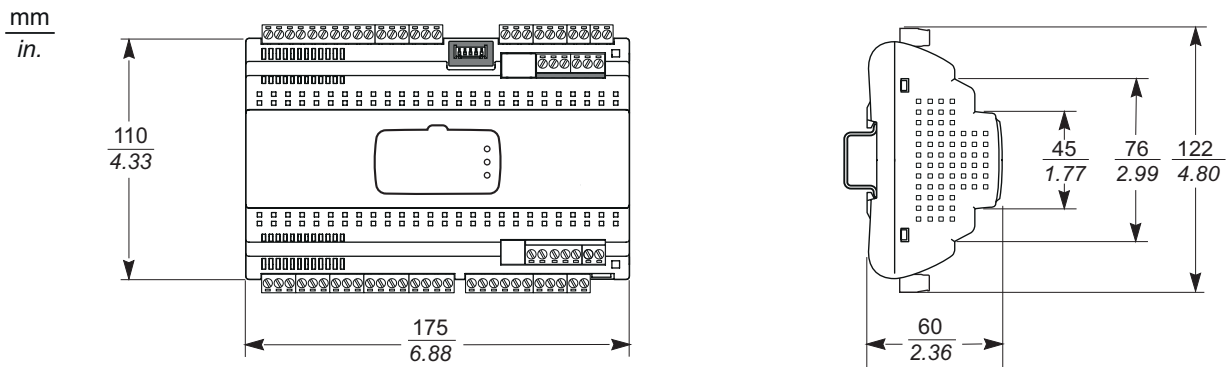

MECHANICAL ASSEMBLY

⚠ WARNING

UNINTENDED EQUIPMENT OPERATION

- Place the devices dissipating the most heat in the top of the cabinet and ensure suitable ventilation.
- Do not place these devices near or above any devices which could cause overheating.
- Install the device in a point that guarantees the minimum distances from all structures and adjacent equipment as indicated in this document.
- Install all devices in conformity with the technical specifications given in the respective documentation.

Failure to follow these instructions can result in death, serious injury, or equipment damage.

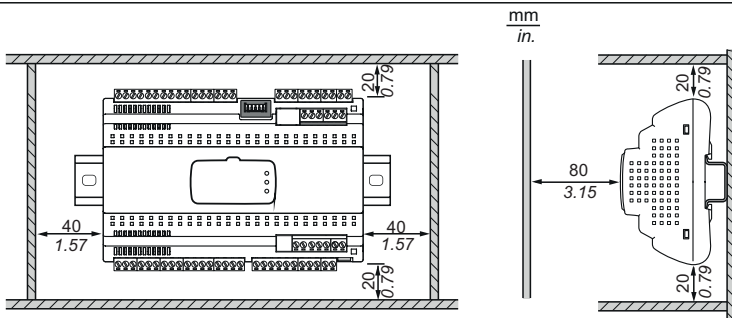
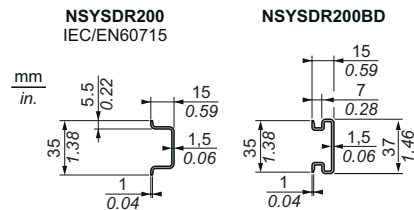
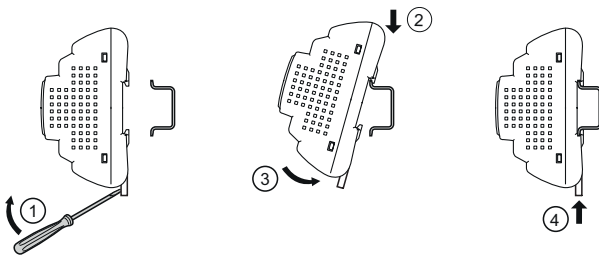

TECHNICAL DATA

The product also complies with the following harmonized standards: EN 60730-1 and EN 60730-2-9

Construction of control:	Incorporated electronic control device
Purpose of control:	Operating control (non-safety related) device
Mounting:	DIN rail mount
Type of action:	1.C
Pollution class:	2
Overvoltage category:	II
Rated pulse voltage:	2500 V
Environmental operating conditions:	Temperature: -5.0...50.0 °C (23.0...122 °F) - Humidity: 10...90 % RH (non-condensing)
Transportation and storage conditions:	Temperature: -30.0...50.0 °C (-22.0...122 °F) - Humidity: 10...90 % RH (non-condensing)
Power supply:	SMPS 100...240 Vac (±10 %) 50/60 Hz
EEV auxiliary power supply:	24 Vac (±10 %) 50/60 Hz (via external safety transformer, maximum absorption 35 VA)
Power draw (maximum):	12.5 W
Software class:	A

LOADS:	OUTPUT	DESCRIPTION	EN 60730 (maximum 230 Vac)	UL 60730 (maximum 230 Vac)
	OUT1	SPST relay	NO 12(5) A	NO: 12 A resistive, 5FLA 30LRA
	OUT2	SPST relay	NO 12(5) A	NO: 12 A resistive, 5FLA 30LRA
	OUT3	SPDT relay	NO 12(5) A - NC 12 A resistive	NO: 12 A resistive, 5FLA 30LRA NC: 12 A resistive
	OUT4	SPDT relay	NO 8(4) A - NC 6(3) A	NO: 8 A resistive, 4.9FLA, 29.4LRA NC: 6 A resistive
	OUT5	SPST relay	NO 8(4) A	NO: 8 A resistive, 4.9FLA, 29.4LRA

FURTHER INFORMATION

Input Characteristics

Display range:	NTC: -50.0...110 °C (-58.0...230 °F) } PTC: -55.0...150 °C (-67.0...302 °F) } (on 3-digit display with sign) Pt1000: -60.0...150 °C (-76.0...302 °F) }
Accuracy:	±1.0 °C/°F for temperatures below -30.0 °C (-22.0 °F) ±0.5 °C/°F for temperatures between -30.0...25.0 °C (-22.0...77.0 °F) ±1.0 °C/°F for temperatures above 25 °C (77 °F)
Resolution:	1 or 0.1 °C/°F
Analogue/Digital Inputs:	5 NTC / PTC / Pt1000 / DI configurable inputs (Pb1...Pb5) 1 4...20 mA / DI configurable input (Pb6) 1 ratiometric / DI configurable input (Pb7) 1 multifunction digital voltage free input (DI)
OC (Open Collector) output:	1 multifunctional output: 12 Vdc - 20 mA
DAC output:	1 multifunctional output: 0...10 Vdc / 4...20 mA
EEV stepper driver output:	1 5-way connector for valve control (maximum current 0.8 A per winding)

Mechanical Characteristics

Dimension:	10 DIN Rail
Terminals:	Removable
Connettori:	1 TTL serial used to connect UNICARD / Device Manager (via DMI) / Multi Function Key (maximum length 3 m / 9.84 ft.) 1 RS-485 serial opto-isolated for monitoring 1 serial for connection to local Link ² network 1 serial for connect a terminal (KDEPlus, KDWPlus, KDT o KDX) or a display (ECPlus) NOTE: for connection use only BELDEN type "twisted" and shielded cable

Other

Buzzer:	NO
RTC duration:	The clock will remain on for 4 days with no external power supply

NOTE: The technical specifications relating to measurement (range, accuracy, resolution, etc.) refer to the device in the strict sense, not to any of the accessories (for example probes).

CONNECTION DIAGRAM

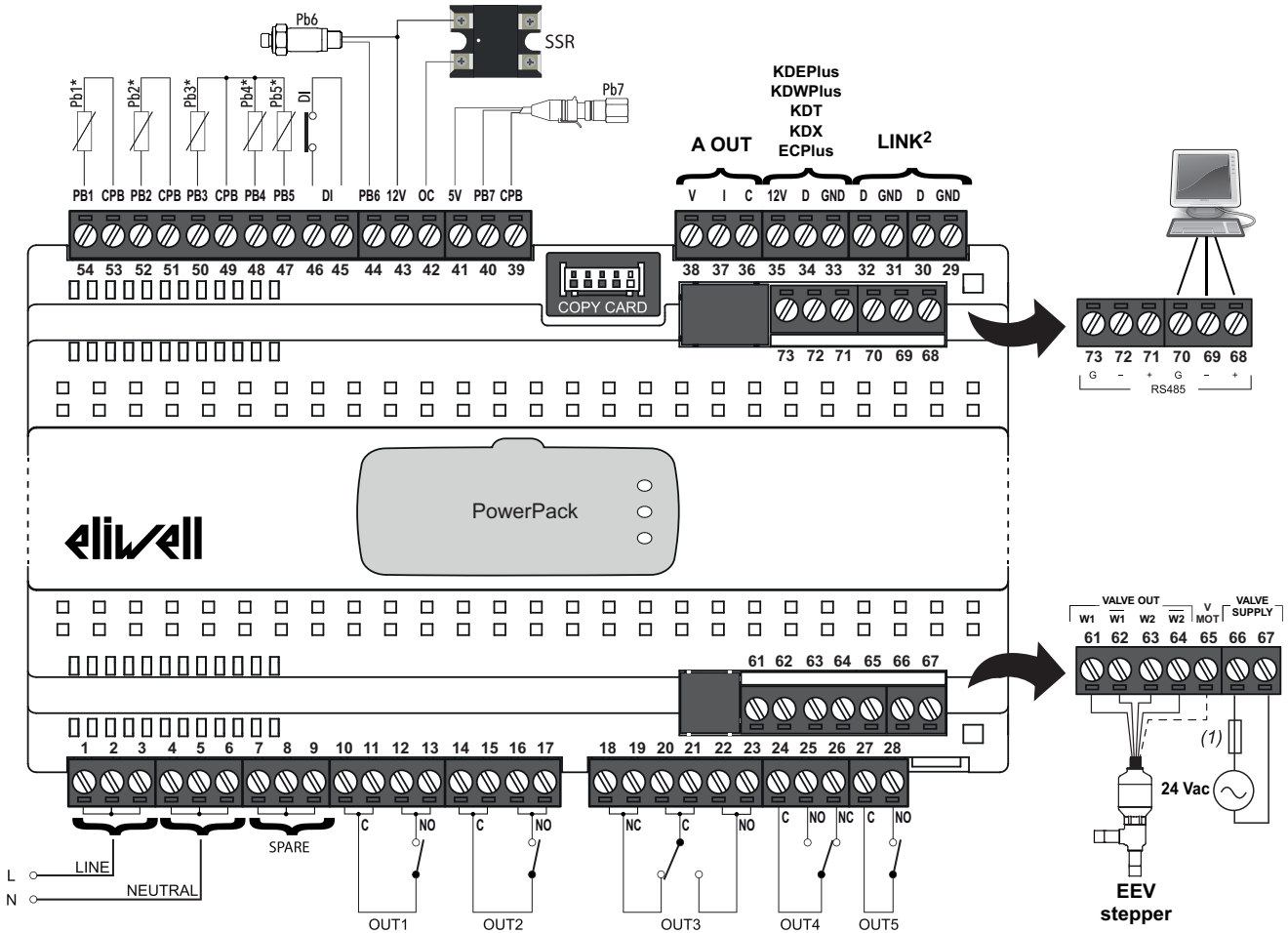

* Pb1...Pb5 analogue inputs can also be configured as Digital Inputs (DI).

(1) Fuse type T 3,15 A

TERMINALS

1-2-3	(LINE) Power line	29-30	LINK ² . Connection 1 - local network
4-5-6	(NEUTRAL) Neutral power supply	31-32	LINK ² . Connection 2 - local network
7-8-9	(SPARE) Auxiliary terminals not connected internally	33-34-35	Connection to KDEPlus , KDWPlus , KDT or KDX terminal or ECPlus display
10-11	(C) OUT1 Common terminal	36-38	A OUT. Voltage analogue output (0...10 V)
12-13	(NO) OUT1 Normally Open	36-37	A OUT. Current analogue output (4...20 mA)
14-15	(C) OUT2 Common terminal	Copy Card	TTL connection to UNICARD/DMI/Multi Function Key
16-17	(NO) OUT2 Normally Open	39-40-41	Pb7 probe connection (ratiometric transducer)
18-19	(NC) OUT3 Normally Closed	43-42	Open collector output (12V - OC)
20-21	(C) OUT3 Common terminal	43-44	Pb6 probe connection (pressure transducer)
22-23	(NO) OUT3 Normally Open	45-46	Digital input (DI)
24	(C) OUT4 Common terminal	49-47	Pb5 probe connection
25	(NO) OUT4 Normally Open	49-48	Pb4 probe connection
26	(NC) OUT4 Normally Closed	49-50	Pb3 probe connection
27	(C) OUT5 Common terminal	51-52	Pb2 probe connection
28	(NO) OUT5 Normally Open	53-54	Pb1 probe connection
61-62	W1 terminals for connection to stepper valve first winder	66-67	EEV Stepper valve external power supply (24 Vac)
63-64	W2 terminals for connection to stepper valve second winder	68-69-70	RS-485. Connection 1 - Supervision gateway
65	Common terminal for unipolar valves	71-72-73	RS-485. Connection 2 - Supervision gateway
		PowerPack	PowerPack position

⚠ ⚠ DANGER









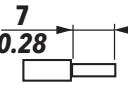

LOOSE WIRING CAUSES ELECTRIC SHOCK



- Tighten the connections in compliance with the technical specifications for torque values and make sure the wiring is correct.
- Do not insert more than one wire per terminal board connector unless you are using the ends of the cables (ferrules).

Failure to follow these instructions will result in death or serious injury.

Use copper wires (obligatory).

The table below shows the type and size of permitted cables for the type of removable screw terminal blocks and the torque values:

									
	mm ²	0.2...2.5	0.2...2.5	0.25...2.5	0.25...2.5	2 x 0.2...1	2 x 0.2...1.5	2 x 0.25...1	2 x 0.5...1.5
	AWG	24...14	24...14	22...14	22...14	2 x 24...18	2 x 24...16	2 x 22...18	2 x 20...16

 Ø 3.5 mm (0.14 in.)		N•m	0.5...0.6
		lb-in	4.42...5.31

⚠ WARNING

HAZARD OF OVERHEATING AND/OR FIRE

- Power lines and output connections must be suitably wired and protected by means of fuses when required by national and local regulations.
- Use only the recommended wire cross-sections for the current capacity of the I/O channels and the electrical power.
- Connect the relay outputs, including the shared hub, using cables with a cross-section of 2.0 mm² (AWG 14), with a nominal temperature value of at least 80 °C (176 °F).

Failure to follow these instructions can result in death, serious injury, or equipment damage.

NOTICE

INOPERABLE DEVICE

Before switching on the electrical power, check all the wiring connections.

Failure to follow these instructions can result in equipment damage.

ELECTRONIC EXPANSION VALVE (EEV)

The device is set to manage bipolar “Stepper” valves. The wiring diagram is as follows:

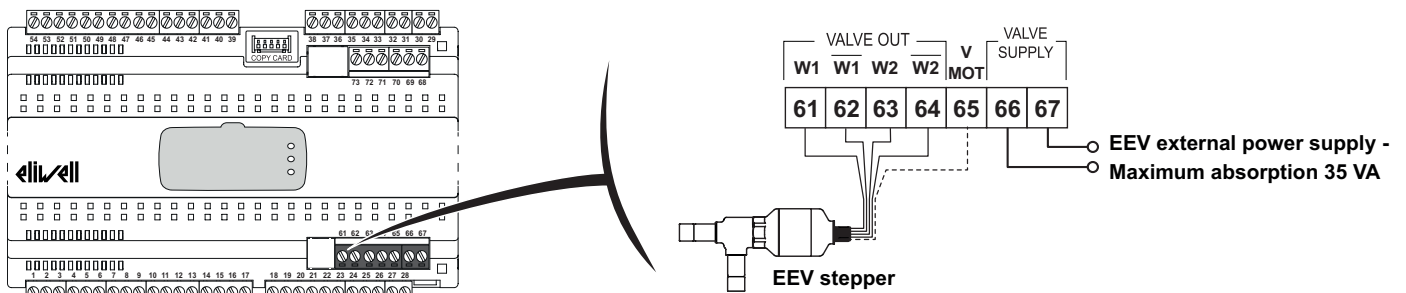

Before connecting the valve, carefully configure the RTX 600 /VS by selecting the type of valve from the list of managed valves.

⚠ WARNING

UNINTENDED EQUIPMENT OPERATION

Verify the valve parameters declared by the manufacturer before using the valve in generic valve configuration.

Failure to follow these instructions can result in death, serious injury, or equipment damage.

Schneider Electric and Eliwell are not liable for the data provided by the valve manufacturer, including any technical modifications or updates. Consult the product manual and the valve manual to check the suitability and correct configuration.

NOTICE

INOPERABLE DEVICE

- Verify all the wiring before switching on the electrical power supply.
- Verify the plate data before connecting the valve.











































Failure to follow these instructions can result in equipment damage.

DEFAULT APPLICATIONS







DESCRIPTION OF APPLICATIONS

Below a short description of the default applications:

- AP1:** NT "CABINETS" (0 °C / 32 °F) for storage of dairy products and fruit/vegetables.
- AP2:** MT "CABINETS" (3 °C / 37,4 °F) for storage of dairy products and fruit/vegetables.
- AP3:** LT "CABINETS" (-18 °C / 0,4 °F) for the storage of frozen foods.
- AP4:** NT "COLDROOMS" TN (0 °C / 32 °F) for storage of dairy products and fruit/vegetables.
- AP5:** MT "COLDROOMS" TM (3 °C / 37,4 °F) for storage of dairy products and fruit/vegetables.
- AP6:** LT "COLDROOMS" BT (-18 °C / 0,4 °F) for the storage of frozen foods.
- AP7:** LT "HORIZONTAL ISLANDS" (-18 °C / 0,4 °F) for the storage of frozen foods.
- AP8:** LT "COMBINED VERTICAL CABINETS" (-18 °C / 0,4 °F) for the storage of frozen foods.





Function / Application		AP1	AP2	AP3	AP4	AP5	AP6	AP7	AP8
INPUTS									
Pb1	NTC	REG1/((⊙))	REG1/((⊙))	REG1/((⊙))	REG1/((⊙))	REG1/((⊙))	REG1/((⊙))	REG1/((⊙))	REG1/((⊙))
Pb2	NTC								REG2/((⊙))
Pb3	NTC	/	/	/	/	/	/	/	
Pb4	NTC	/	/	/	/	/	/	/	/
Pb5	NTC	EEV	EEV	EEV	EEV	EEV	EEV	EEV	EEV
Pb6	4...20 mA	EEV	EEV	EEV	EEV	EEV	EEV	EEV	EEV
Pb7	Ratiometric	/	/	/	/	/	/	/	/
DI	Digital Input	/	/	/				/	/
OUTPUTS									
OUT1	relay								
OUT2	relay								
OUT3	relay								
OUT4	relay								
OUT5	relay	AUX	AUX	AUX	/	/	/	/	/
EEV	output	EEV	EEV	EEV	EEV	EEV	EEV	EEV	EEV
A OUT	output	/	/	/	/	/	/	/	/
OC	output	/	/	/	/	/	/	/	/
INPUTS / OUTPUTS ONLY PRESENT ON KDX TERMINAL									
Pb8	4...20 mA (KDX)	/	/	/	/	/	/	/	/
DI1	Digital Input	/	/	/	/	/	/	/	/
DI2	Digital Input	/	/	/	/	/	/	/	/

Legend

REG1	Regulator 1		Alarm regulator
REG2	Regulator 2		Defrost regulator
EEV	EEV input or output		Compressor regulator
AUX	Auxiliary output regulator		Fans regulator
	Door switch regulator		Light regulator

LOADING DEFAULT APPLICATIONS













The procedure for loading one of the default applications is:

- Switch on the terminal connected to the device by pressing and holding **SET** until the label "AP1" appears.
NOTE: On the **KDT** terminal, within 30 seconds from the end of the lamp test, press any key for at least 1 second to exit the "stand-by" mode and then press the **SET** +  together until the label "AP1" appears.
NOTE: On the **KDX** terminal, within 30 seconds from the end of the lamp test, press the **SET** +  together until the label "AP1" appears.
- Scroll through applications **AP1...AP8** using  and .
- Confirm the selected preset application using **SET**.
NOTE: The process can be canceled by pressing  key or letting a timeout occur (15 seconds).
- If the procedure was completed successfully, the display will show "yES"; otherwise it will show "Err".
- The regulator will restart and revert to showing the main display.

The procedure for loading one of the preset applications restores the respective default values, with the exception of the parameters **NON** specific to the application that retain the value set previously. These values, left unaltered, may not be suitable and may therefore need to be changed.

NOTICE
INOPERABLE DEVICE
Verify the parameters after loading a preset application.
Failure to follow these instructions can result in equipment damage.

TERMINALS INTERFACE

KEYS*			
	UP Press and release Scrolls through menu options Increases values Press and hold for at least 5 seconds Default: defrost manual activation User-configurable function		DOWN Press and release Scrolls through menu options Decreases values Press and hold for at least 5 seconds Default: not configured User-configurable function
	STAND-BY (ESC) Press and release Goes back up one level from current menu Confirms parameter value Press and hold for at least 5 seconds Default: stand-by manual activation User-configurable function		SET (ENTER) Press and release Displays alarms (if present) Opens Machine Status menu Confirms commands Press and hold for at least 5 seconds Opens Programming menu
ICONS*			
	Reduced SET / Economy Permanently on: energy saving active Flashing: reduced set active Off: otherwise		Alarm Permanently on: presence of an alarm Flashing: alarm acknowledged Off: otherwise
	Compressor Permanently on: compressor active Flashing: delay, protection or activation locked Off: otherwise		Defrost Permanently on: defrost active Flashing: manual activation or activation via digital input Off: otherwise
	Fans Permanently on: fans active Off: otherwise		AUX Permanently on: AUX output active and/or light on Flashing: deep cooling cycle active
	°C Permanently on: values displayed in °C (dro=0) Off: otherwise		°F Permanently on: values displayed in °F (dro=1) Off: otherwise

(*) For the complete list of keys and icons of the dedicated terminals, consult the User Manual.

CONNECTIONS WITH USER TERMINAL AND REMOTE DISPLAY

Each RTX 600 /VS can be connected to a single KDEPlus, KDWPlus, KDT or KDX terminal and to an ECPlus display module for remote display.

RTX 600 /VS + KDEPlus + ECPlus CONNECTION

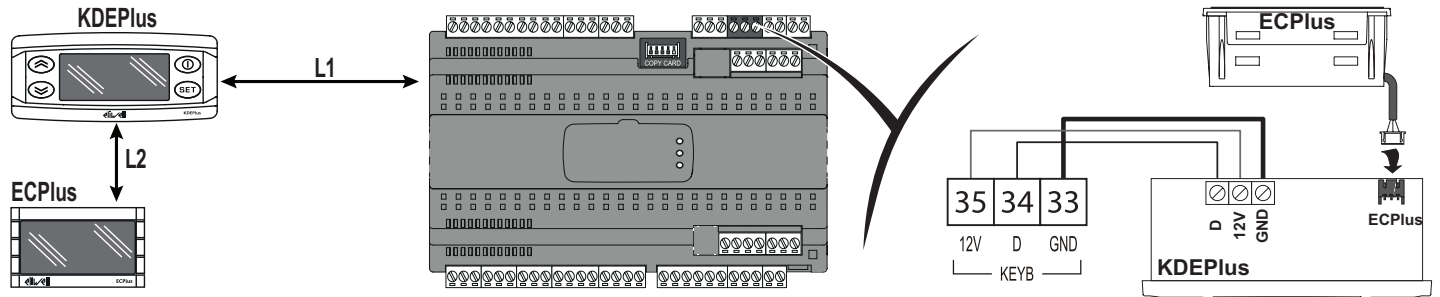

Legend: L1 = maximum 15 m / 49,21 ft; L2 = maximum 85 m / 278,87 ft

RTX 600 /VS + KDWPlus + ECPlus CONNECTION

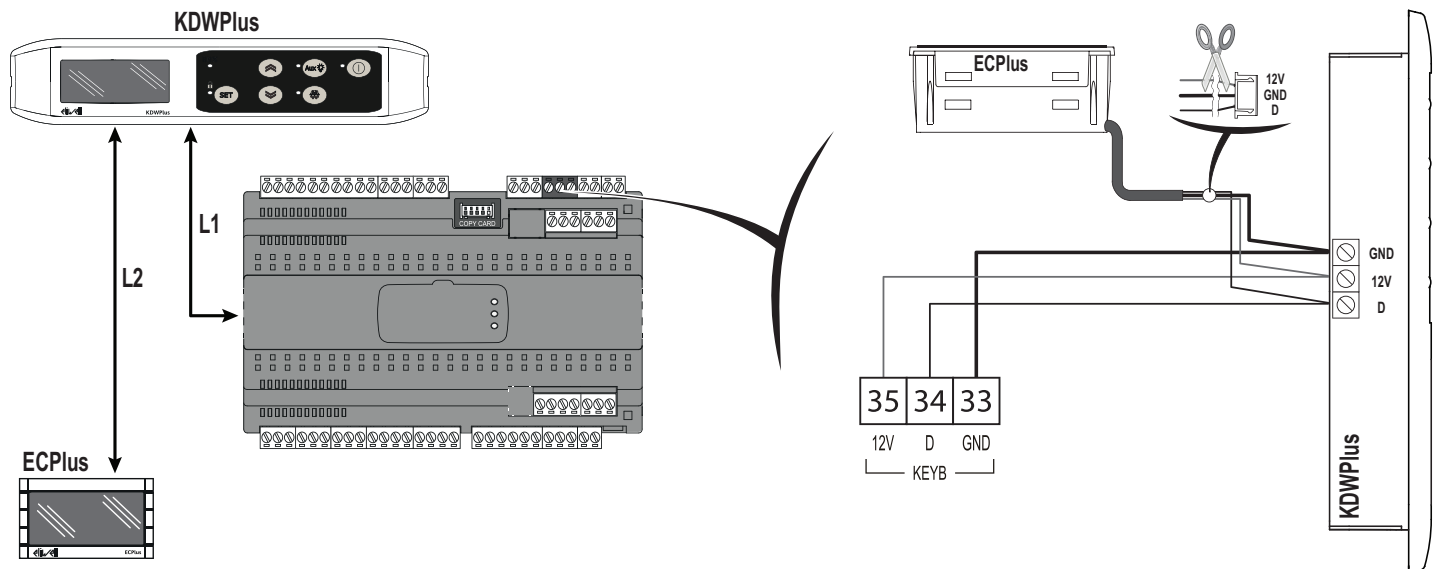

Legend: L1 = maximum 15 m / 49,21 ft; L2 = maximum 85 m / 278,87 ft.

Notes: - An ECPlus display can be connected to the KDWPlus using the same terminal as the base is connected to.
- the following parameter SHALL be configured: H31 = 0

RTX 600 /VS + KDT CONNECTION

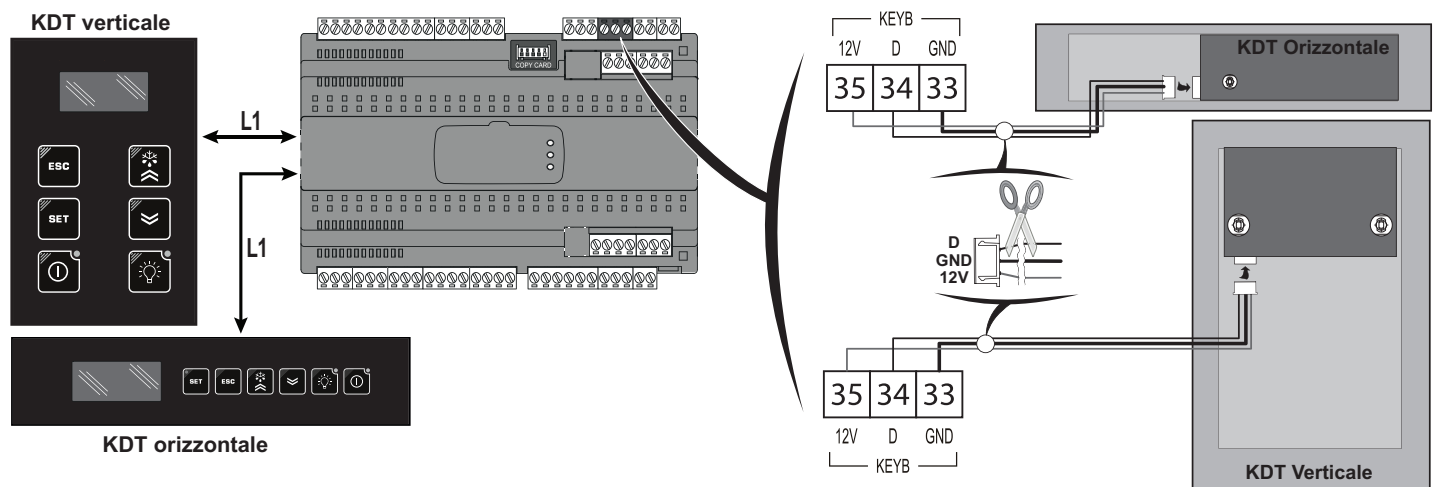

Legend: L1 = maximum 100 m / 328,08 ft.

RTX 600 /VS + KDX CONNECTION

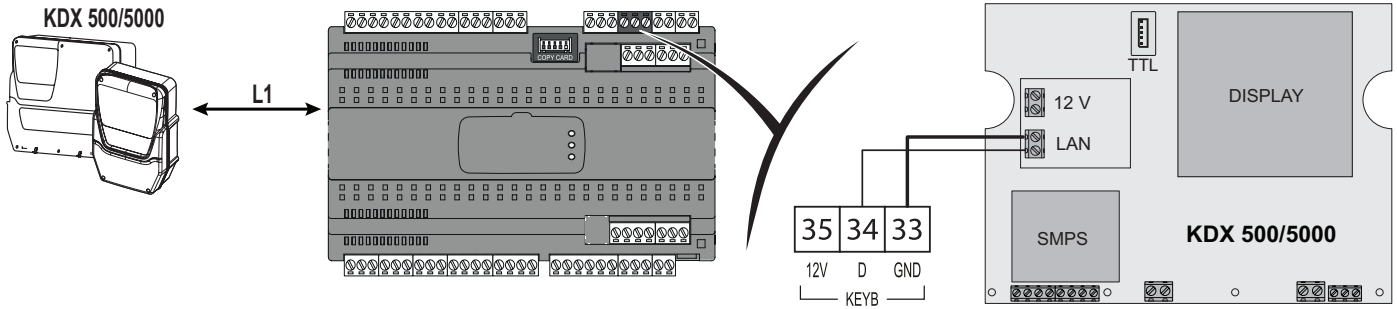

Legend: L1 = maximum 100 m / 328,08 ft.

Note: the following parameters SHALL be configured: H31 = 0; H32 = 5 and H33 = 1.

RTX 600 /VS + ECPlus CONNECTION

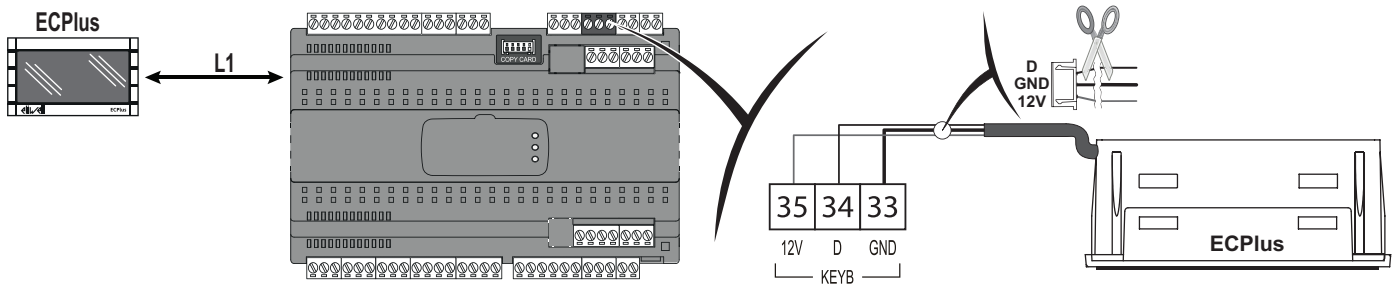

Legend: L1 = maximum 100 m / 328,08 ft.

LOCAL AND MONITORING NETWORK

It is possible to connect up to a maximum of 8 **RTX 600 /VS** devices in a Link² local network and to connect only one device to the Modbus monitoring network, which will act as gateway for the other devices connected to the local network. Configuration of the Link² uses the same addresses of the supervision system.

DEVICE MANAGER

RTX 600 /VS can interface with the “Device Manager” software through the DMI interface. This connection allows the value/visibility of fixed parameters and parameters present in vectors to be controlled from a PC.

DIAGNOSTICS

Alarms are always indicated by the buzzer (if present) and the alarm icon (☉). To acknowledged the alarm, press and release any key, the relative icon will continue to flash. If alarm exclusion times have been set (see “AL” folder in the parameters table) the alarm will not be indicated. For the list of alarms, consult the User Manual.

LIABILITY AND RESIDUAL RISKS

The liability of Schneider Electric and Eliwell is limited to the correct and professional use of the product according to the directives referred to herein and in the other supporting documents, and does not cover any damage (including but not limited to) the following causes:

- installation/use other than what is intended and, in particular, in deviation from the safety regulations set forth by the standards and/or included in this document;
- use on panels that do not guarantee suitable protection against electrical shock, water and dust in the assembly conditions;
- use on panels which allow access to dangerous parts without the aid of a keyed or tooled locking mechanism;
- product tampering and/or alteration;
- installation/use on panels that do not comply with the regulations in force in the country of installation.

CONDITIONS OF USE

Permitted use

The device must be installed and used in accordance with the provided instructions and in particular, in normal conditions, dangerous energized parts must not be accessible. The device must be suitably protected against water and dust based on the application and must also be accessible only with the use of a keyed or tooled locking mechanism (with the exception of the front panel). The device is suited for being integrated in equipment for domestic use and/or similar for refrigeration purposes and has been checked on the basis of the harmonized European standards of reference.

Prohibited use

Any use other than what is permitted is in fact prohibited. Please note that the relay contacts provided are a functional type and are subject to faults: any protective devices indicated by product regulations or suggested as a result of common sense with regard to obvious safety needs must be implemented outside of the device.

DISPOSAL



The device (or product) must be collected separately in compliance with current regulations on disposal.

Eliwell Controls s.r.l.

Via dell'Industria, 15 • Z.I. Paludi

32016 Alpago (BL) - ITALY

T: +39 0437 986 111

F: +39 0437 989 066

www.eliwell.com

Technical Customer Support:

T: +39 0437 986 300

E: Techsuppeliwell@schneider-electric.com

Sales:

T: +39 0437 986 100 (Italy)

T: +39 0437 986 200 (other countries)

E: saleseliwell@schneider-electric.com

MADE IN ITALY

RTX 600 /VS DOMINO ZERO • EN
© 2020 Eliwell • All rights reserved.



9IS2473700

Per maggiori informazioni sul prodotto, scansiona il codice QR tramite l'app myEliwell per accedere al manuale utente

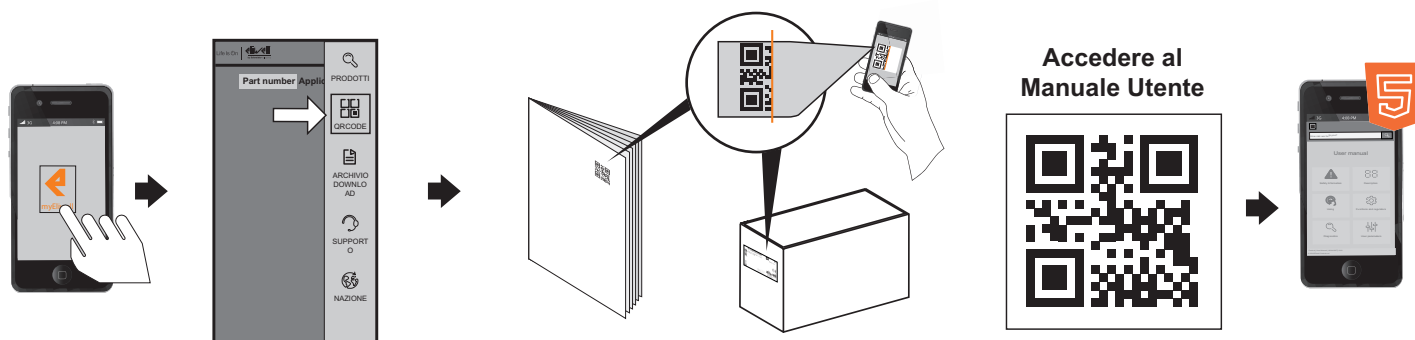

Se la app "myEliwell" () non è stata ancora scaricata, puoi farlo da:



o



CONNESSIONI ELETTRICHE

PERICOLO

RISCHIO DI SHOCK ELETTRICO, ESPLOSIONE O ARCO ELETTRICO

- Mettere fuori tensione tutte le apparecchiature, inclusi i dispositivi collegati, prima di rimuovere qualunque coperchio o sportello, o prima di installare/disinstallare accessori, hardware, cavi o fili, tranne che per le condizioni specificate nel manuale utente.
- Per verificare che il sistema sia fuori tensione, usare sempre un voltmetro correttamente tarato al valore nominale della tensione.
- Prima di rimettere il dispositivo sotto tensione rimontare e fissare tutti i coperchi, i componenti hardware e i cavi.
- Per tutti i dispositivi che lo prevedono, verificare la presenza di un buon collegamento di terra.
- Utilizzare questo dispositivo e tutti i prodotti collegati solo alla tensione specificata.
- Non collegare il dispositivo direttamente alla tensione di linea, salvo dove espressamente indicato.

Il mancato rispetto di queste istruzioni provocherà morte o gravi infortuni.

PERICOLO

RISCHIO DI SURRISCALDAMENTO E INCENDIO

- Non utilizzare con carichi differenti da quelli indicati nei dati tecnici.
- Non superare la corrente massima consentita; in caso di carichi superiori usare un contattore di adatta potenza.

Il mancato rispetto di queste istruzioni provocherà morte o gravi infortuni.

AVVERTIMENTO

FUNZIONAMENTO ANOMALO DELL'APPARECCHIATURA

- Usare cavi schermati per tutti i segnali di I/O analogici e di comunicazione.
- Collegare a massa gli schermi dei cavi per tutti i segnali di I/O analogici, I/O ad alta velocità e di comunicazione in un unico punto.
- I cavi di segnale (sonde, ingressi digitali, comunicazione, e relative alimentazioni) devono essere instradati separatamente dai cavi di potenza e di alimentazione del dispositivo.
- Ridurre il più possibile la lunghezza di fili e cavi ed evitare di avvolgerli intorno a parti collegate elettricamente.

Il mancato rispetto di queste istruzioni può provocare morte, gravi infortuni o danni alle apparecchiature.

Le **sonde di temperatura** (NTC, PTC, Pt1000) non sono caratterizzate da alcuna polarità di inserzione e possono essere allungate utilizzando del normale cavo bipolare. L'allungamento delle sonde grava sul comportamento del dispositivo dal punto di vista della compatibilità elettromagnetica EMC.

I **trasduttori raziometrici** (0...5 V) e di **pressione** (4...20 mA), sono caratterizzati da una polarità di inserzione.

Le apparecchiature elettriche devono essere installate, usate e riparate solo da personale qualificato. Schneider Electric e Eliwell non si assumono nessuna responsabilità per qualunque conseguenza derivante dall'uso di questo materiale.

GAS REFRIGERANTI INFIAMMABILI

Questa apparecchiatura è stata progettata per funzionare al di fuori di qualsiasi area pericolosa e sono escluse le applicazioni che generano, o hanno il potenziale per generare, atmosfere pericolose. Installare questa apparecchiatura esclusivamente in zone e applicazioni notoriamente sempre prive di atmosfere pericolose.

⚠ PERICOLO

RISCHIO DI ESPLOSIONE

- Installare ed utilizzare questa apparecchiatura solo in luoghi non a rischio.
- Non installare e utilizzare questa apparecchiatura in applicazioni in grado di generare atmosfere pericolose, come quelle che impiegano refrigeranti infiammabili.

Il mancato rispetto di queste istruzioni provocherà morte o gravi infortuni.

Per informazioni sull'utilizzo di apparecchiature di controllo in applicazioni in grado di generare materiali pericolosi, consultare l'ufficio normative o l'ente di certificazione locale, regionale o nazionale.

DIMENSIONI

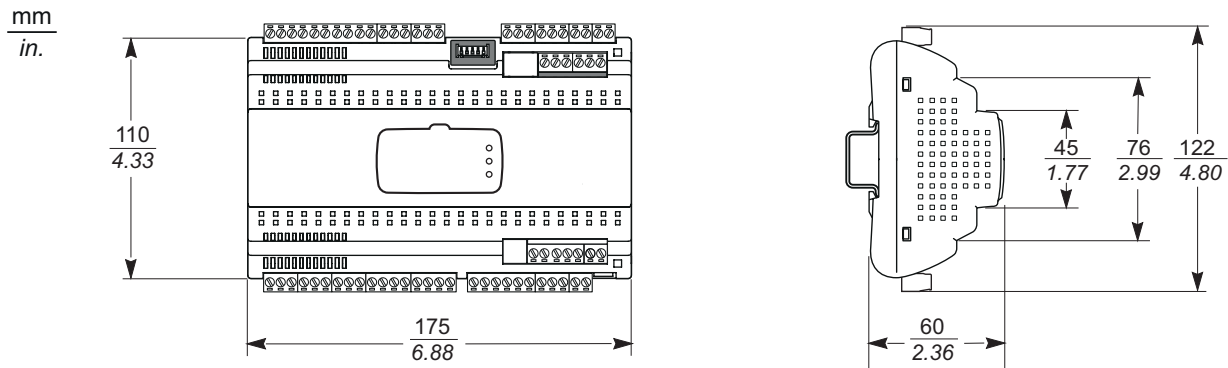

MONTAGGIO MECCANICO

⚠ AVVERTIMENTO

FUNZIONAMENTO ANOMALO DELL'APPARECCHIATURA

- Collocare i dispositivi che dissipano la maggiore quantità di calore in corrispondenza della parte superiore dell'armadio e garantire una ventilazione adeguata.
- Evitare di collocare questo dispositivo in prossimità o al di sopra di dispositivi che potrebbero dare luogo a surriscaldamento.
- Installare il dispositivo in un punto che garantisce le distanze minime da tutte le strutture e apparecchiature adiacenti come indicato nel presente documento.
- Installare tutti i dispositivi in conformità alle specifiche tecniche indicate nella rispettiva documentazione.

Il mancato rispetto di queste istruzioni può provocare morte, gravi infortuni o danni alle apparecchiature.

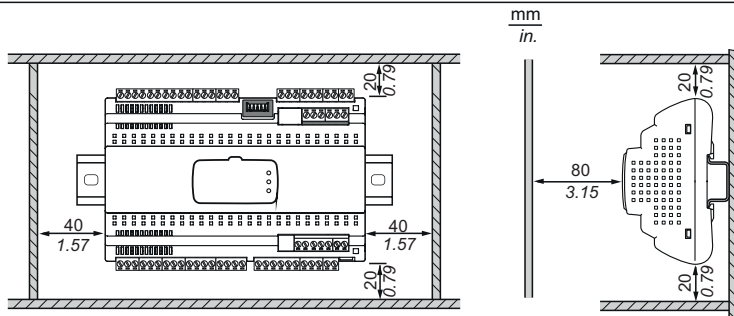
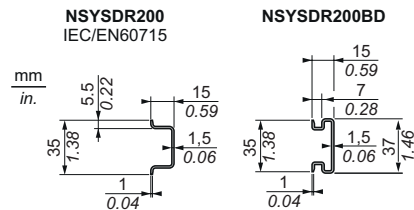
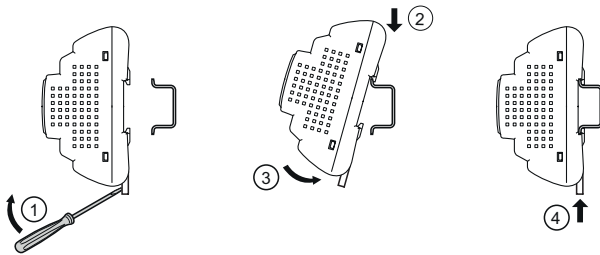

NSYSDR200T



DATI TECNICI

Il prodotto risulta conforme alle seguenti Norme armonizzate: EN 60730-1 e EN 60730-2-9

Costruzione del dispositivo:	Dispositivo elettronico di comando incorporato
Scopo del dispositivo:	Dispositivo di comando di funzionamento (non di sicurezza)
Montaggio:	Montaggio su barra DIN
Tipo di azione:	1.C
Grado di inquinamento:	2
Categoria di sovratensione:	II
Tensione impulsiva nominale:	2500 V
Condizioni operative ambientali:	Temperatura: -5,0...50,0 °C (23,0...122 °F) - Umidità: 10...90 % RH (non condensante)
Condizioni di trasporto e immagazzinamento:	Temperatura: -30,0...50,0 °C (-22,0...122 °F) - Umidità: 10...90 % RH (non condensante)
Alimentazione:	SMPS 100...240 Vac (±10 %) 50/60 Hz
Alimentazione ausiliaria EEV:	24 Vac (±10 %) 50/60 Hz (tramite trasformatore di sicurezza esterno, massimo assorbimento 35 VA)
Consumo (massimo):	12,5 W
Classe del software:	A
Carichi:	

USCITA	DESCRIZIONE	EN 60730 (massimo 230 Vac)	UL 60730 (massimo 230 Vac)
OUT1	relé SPST	NO 12(5) A	NO: 12 A resistivi, 5FLA 30LRA
OUT2	relé SPST	NO 12(5) A	NO: 12 A resistivi, 5FLA 30LRA
OUT3	relé SPDT	NO 12(5) A - NC 12 A resistivi	NO: 12 A resistivi, 5FLA 30LRA NC: 12 A resistivi
OUT4	relé SPDT	NO 8(4) A - NC 6(3) A	NO: 8 A resistivi, 4,9FLA, 29,4LRA NC: 6 A resistivi
OUT5	relé SPST	NO 8(4) A	NO: 8 A resistivi, 4,9FLA, 29,4LRA

ULTERIORI INFORMAZIONI

Caratteristiche Ingressi

Campo di misura:	NTC: -50,0...110 °C (-58,0...230 °F) } PTC: -55,0...150 °C (-67,0...302 °F) } (su display con 3 digit + segno) Pt1000: -60,0...150 °C (-76,0...302 °F) }
Accuratezza:	±1,0 °C/°F per temperature inferiori a -30,0 °C (-22,0 °F) ±0,5 °C/°F per temperature comprese tra -30,0...25,0 °C (-22,0...77,0 °F) ±1,0 °C/°F per temperature superiori a 25 °C (77 °F)
Risoluzione:	1 oppure 0,1 °C/°F
Ingressi Analogici/Digitali:	5 ingressi NTC / PTC / Pt1000 / DI configurabili (Pb1...Pb5) 1 ingresso 4...20 mA / DI configurabile (Pb6) 1 ingresso raziometrico / DI configurabile (Pb7) 1 ingresso digitale multifunzione libero da tensione (DI)
Uscita OC (Open Collector):	1 uscita multifunzione: 12 Vdc - 20 mA
Uscita DAC:	1 uscita multifunzione: 0...10 Vdc / 4...20 mA
Uscita driver EEV stepper:	1 Connettore a 5 vie per comando valvola (corrente massima 0,8 A per avvolgimento)

Caratteristiche Meccaniche

Dimensioni:	10 DIN Rail
Morsetti:	Sconnettibili
Connettori:	1 seriale TTL per collegamento UNICARD / Device Manager (via DMI) / Multi Function Key (lunghezza massima 3 m / 9,84 ft.) 1 seriale RS-485 opto-isolata per supervisione 1 seriale per collegamento rete Link ² locale 1 seriale per collegare un terminale (KDEPlus, KDWPlus, KDT o KDX) o un visualizzatore (ECPlus)
	NOTA: per le connessioni usare solo cavo "twistato" e schermato tipo BELDEN

Altro

Buzzer:	NO
Durata RTC:	In assenza di alimentazione esterna, l'orologio verrà mantenuto per 4 giorni

NOTA: Le caratteristiche tecniche inerenti la misura (range, accuratezza, risoluzione, ecc.) si riferiscono al dispositivo in senso stretto e non ad eventuali accessori (ad esempio sonde).

SCHEMA CONNESSIONI

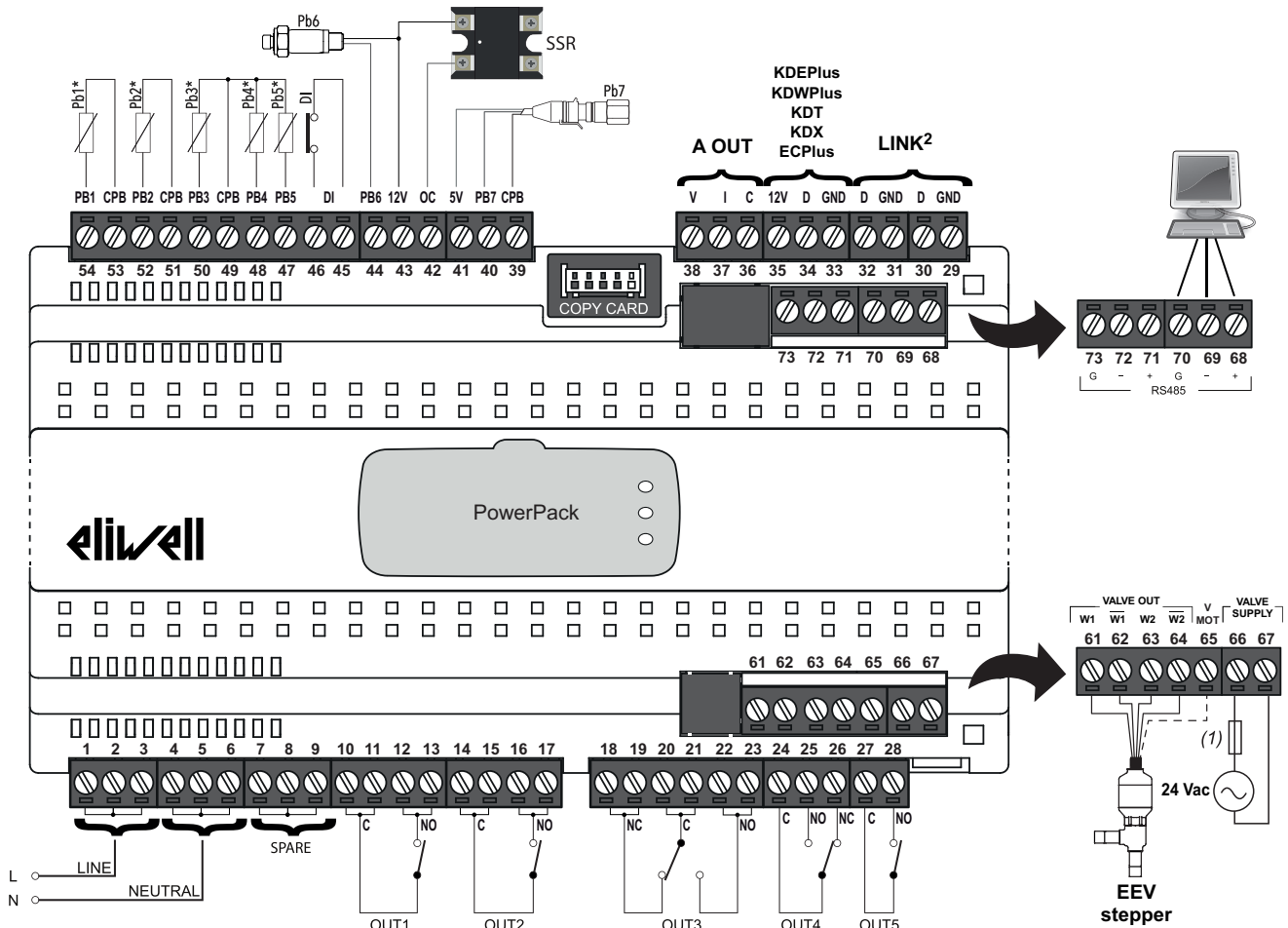

* Gli ingressi analogici Pb1...Pb5 possono essere configurati anche come Ingressi Digitali (DI).

(1) Fusibile tipo T 3,15 A

MORSETTI

1-2-3	(LINE) Linea alimentazione	29-30	LINK ² . Connessione 1 - rete locale
4-5-6	(NEUTRAL) Neutro alimentazione	31-32	LINK ² . Connessione 2 - rete locale
7-8-9	(SPARE) Morsetti di appoggio non collegati internamente	33-34-35	Connessione con il terminale KDEPlus , KDWPlus , KDT o KDX o con il visualizzatore ECPlus
10-11	(C) Morsetto Comune OUT1	36-38	A OUT. Uscita analogica in tensione (0...10 V)
12-13	(NO) Normalmente Aperto OUT1	36-37	A OUT. Uscita analogica in corrente (4...20 mA)
14-15	(C) Morsetto Comune OUT2	Copy Card	Connessione TTL a UNICARD/DMI/Multi Function Key
16-17	(NO) Normalmente Aperto OUT2	39-40-41	Connessione sonda Pb7 (trasduttore raziometrico)
18-19	(NC) Normalmente Chiuso OUT3	43-42	Uscita open collector (12V - OC)
20-21	(C) Morsetto Comune OUT3	43-44	Connessione sonda Pb6 (trasduttore di pressione)
22-23	(NO) Normalmente Aperto OUT3	45-46	Ingresso digitale (DI)
24	(C) Morsetto Comune OUT4	49-47	Connessione sonda Pb5
25	(NO) Normalmente Aperto OUT4	49-48	Connessione sonda Pb4
26	(NC) Normalmente Chiuso OUT4	49-50	Connessione sonda Pb3
27	(C) Morsetto Comune OUT5	51-52	Connessione sonda Pb2
28	(NO) Normalmente Aperto OUT5	53-54	Connessione sonda Pb1
61-62	Morsetti W1 per connessione primo avvolgimento valvola stepper	66-67	Alimentazione esterna valvola EEV Stepper (24 Vac)
63-64	Morsetti W2 per connessione secondo avvolgimento valvola stepper	68-69-70	RS-485. Connessione 1 - Gateway di supervisione
65	Morsetto comune per valvole unipolari	71-72-73	RS-485. Connessione 2 - Gateway di supervisione
		PowerPack	Alloggiamento PowerPack

⚠ ⚠ PERICOLO









UN CABLAGGIO ALLENTATO PROVOCA FOLGORAZIONE ELETTRICA

- Serrare le connessioni in conformità con le specifiche tecniche relative alle coppie di serraggio e verificarne il corretto cablaggio.
- Non inserire più di un cavo per connettore della morsetteria, a meno che non si utilizzino le estremità dei cavi (cavicorda).

Il mancato rispetto di queste istruzioni provocherà morte o gravi infortuni.

Usare conduttori in rame (obbligatori).

La tabella seguente riporta tipo e dimensione dei cavi ammissibili per i morsetti a vite sconnettabili e le relative coppie di serraggio:

mm in.	7 0.28								
mm²		0.2...2.5	0.2...2.5	0.25...2.5	0.25...2.5	2 x 0.2...1	2 x 0.2...1.5	2 x 0.25...1	2 x 0.5...1.5
AWG		24...14	24...14	22...14	22...14	2 x 24...18	2 x 24...16	2 x 22...18	2 x 20...16

		N•m	0.5...0.6
Ø 3.5 mm (0.14 in.)		lb-in	4.42...5.31

⚠ AVVERTIMENTO

RISCHIO DI SURRISCALDAMENTO E/O INCENDIO

- Linee d'alimentazione e connessioni d'uscita devono essere opportunamente cablate e protette a mezzo di fusibili quando richiesto da requisiti normativi nazionali e locali.
- Utilizzare soltanto le sezioni dei fili raccomandate per la capacità di corrente dei canali di I/O e delle alimentazioni elettriche.
- Connettere le uscite relè, compreso il polo comune, utilizzando conduttori di sezione almeno pari a 2,0 mm² (AWG 14), con valore di temperatura nominale di almeno 80 °C (176 °F).

Il mancato rispetto di queste istruzioni può provocare morte, gravi infortuni o danni alle apparecchiature.

AVVISO

APPARECCHIATURA NON FUNZIONANTE

Prima di applicare l'alimentazione elettrica, verificare tutti i collegamenti dei cablaggi.

Il mancato rispetto di queste istruzioni può provocare danni alle apparecchiature.

VALVOLA ESPANSIONE ELETTRONICA (EEV)

Il dispositivo è predisposto per la gestione di valvole "Stepper". Lo schema di connessione è il seguente:

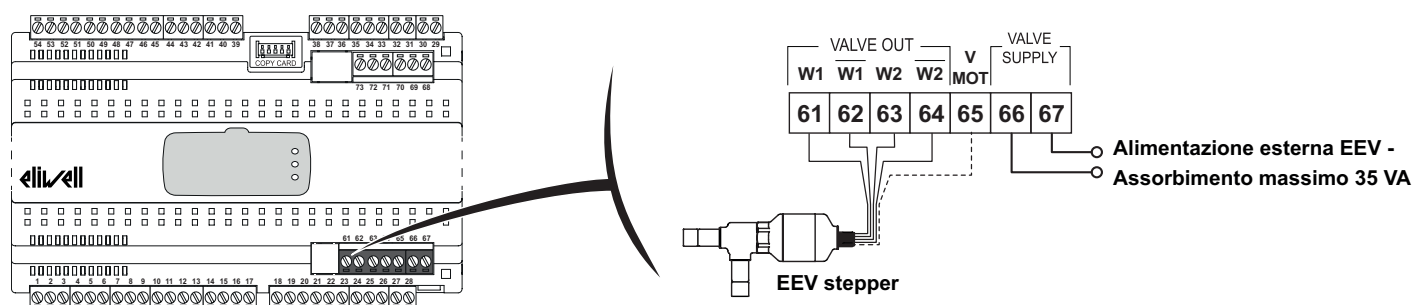

Prima di collegare la valvola, configurare accuratamente l' RTX 600 /VS selezionando il tipo di valvola dall'elenco delle valvole gestite.

⚠ AVVERTIMENTO

FUNZIONAMENTO ANOMALO DELL'APPARECCHIATURA

Verificare le informazioni sui parametri della valvola dichiarate dal costruttore prima di utilizzare la valvola in configurazione di valvola generica.

Il mancato rispetto di queste istruzioni può provocare morte, gravi infortuni o danni alle apparecchiature.

Schneider Electric ed Eliwell non rispondono dei dati forniti dal costruttore della valvola, incluse modifiche tecniche o aggiornamenti. Consultare il manuale del prodotto ed il manuale della valvola per verificarne l'idoneità e la corretta configurazione.

AVVISO

APPARECCHIATURA NON FUNZIONANTE

- Verificare tutti i cablaggi prima di applicare l'alimentazione elettrica.
- Verificare i dati di targa prima di collegare la valvola.

Il mancato rispetto di queste istruzioni può provocare danni alle apparecchiature.

APPLICAZIONI PREDEFINITE

DESCRIZIONE APPLICAZIONI

Di seguito una breve descrizione delle applicazioni predefinite:

AP1: "BANCHI" TN (0 °C / 32 °F) per la conservazione di Latticini, Frutta/Verdura e Surgelati.

AP2: "BANCHI" TM (3 °C / 37,4 °F) per la conservazione di Latticini, Frutta/Verdura e Surgelati.

AP3: "BANCHI" BT (-18 °C / 0,4 °F) per la conservazione di Surgelati.











































AP4: "CELLE" TN (0 °C / 32 °F) per la conservazione di Latticini, Frutta/Verdura e Surgelati.

AP5: "CELLE" TM (3 °C / 37,4 °F) per la conservazione di Latticini, Frutta/Verdura e Surgelati.







AP6: "CELLE" BT (-18 °C / 0,4 °F) per la conservazione di Surgelati.

AP7: "ISOLE ORIZZONTALI" BT (-18 °C / 0,4 °F) per la conservazione di Surgelati.

AP8: "BANCHI VERTICALI COMBINATI" BT (-18 °C / 0,4 °F) per la conservazione di Surgelati.

Funzione / Applicazione		AP1	AP2	AP3	AP4	AP5	AP6	AP7	AP8
INGRESSI									
Pb1	NTC	REG1/((●))	REG1/((●))	REG1/((●))	REG1/((●))	REG1/((●))	REG1/((●))	REG1/((●))	REG1/((●))
Pb2	NTC								REG2/((●))
Pb3	NTC	/	/	/	/	/	/	/	
Pb4	NTC	/	/	/	/	/	/	/	/
Pb5	NTC	EEV	EEV	EEV	EEV	EEV	EEV	EEV	EEV
Pb6	4...20 mA	EEV	EEV	EEV	EEV	EEV	EEV	EEV	EEV
Pb7	Raziometrico	/	/	/	/	/	/	/	/
DI	Ingresso Digitale	/	/	/				/	/
USCITE									
OUT1	relè								
OUT2	relè								
OUT3	relè								
OUT4	relè								
OUT5	relè	AUX	AUX	AUX	/	/	/	/	/
EEV	uscita	EEV	EEV	EEV	EEV	EEV	EEV	EEV	EEV
A OUT	uscita	/	/	/	/	/	/	/	/
OC	uscita	/	/	/	/	/	/	/	/
INGRESSI / USCITE PRESENTI SOLO SUL TERMINALE KDX									
Pb8	4...20 mA (KDX)	/	/	/	/	/	/	/	/
DI1	Ingresso Digitale	/	/	/	/	/	/	/	/
DI2	Ingresso Digitale	/	/	/	/	/	/	/	/

Legenda

REG1	Regolatore 1		Regolatore allarme
REG2	Regolatore 2		Regolatore sbrinamento
EEV	Ingresso o uscita EEV		Regolatore compressore
AUX	Regolatore uscita ausiliaria		Regolatore ventole
	Regolatore microporta		Regolatore luce

CARICAMENTO APPLICAZIONI PREDEFINITE

La procedura per caricare una delle applicazioni predefinite è:

1. Accendere il terminale collegato al dispositivo tenendo premuto il tasto **SET** fino a quando apparirà la label "AP1".
NOTA: Sul terminale **KDT**, entro 30 secondi dall'accensione, premere per almeno 1 secondo un tasto qualsiasi per sbloccare la tastiera e poi premere contemporaneamente i tasti **SET** + **↵** fino a quando apparirà la label "AP1".
NOTA: Sul terminale **KDX**, entro 30 secondi dall'accensione, premere contemporaneamente i tasti **SET** + **AUX** fino a quando apparirà la label "AP1".
2. Scorrere le applicazioni **AP1** ... **AP8** mediante i tasti **↶** e **↷**.
3. Confermare la scelta dell'applicazione predefinita mediante il tasto **SET**.
NOTA: L'operazione può essere annullata premendo il tasto **⏻** o per time-out (15 secondi).
4. Se l'operazione è avvenuta con successo, il display visualizzerà "yES", in caso contrario visualizzerà "Err".
5. Il regolatore si riavvierà e tornerà alla visualizzazione principale.

La procedura di caricamento di una delle applicazioni predefinite, ripristina i rispettivi valori di default ad eccezione dei parametri NON specifici dell'applicazione che mantengono il valore impostato precedentemente. Questi valori, se non modificati, potrebbero non essere appropriati e potrebbero di conseguenza richiedere modifiche.

AVVISO





APPARECCHIATURA NON FUNZIONANTE

Verificare i parametri dopo il caricamento di una applicazione predefinita.

Il mancato rispetto di queste istruzioni può provocare danni alle apparecchiature.

INTERFACCIA TERMINALI

TASTI*

	UP Premere e rilasciare Scorre le voci del menu Incrementa i valori Premere per almeno 5 secondi Default: attivazione manuale sbrinamento Funzione configurabile dall'utente		DOWN Premere e rilasciare Scorre le voci del menu Decrementa i valori Premere per almeno 5 secondi Default: non configurato Funzione configurabile dall'utente
	STAND-BY (ESC) Premere e rilasciare Torna su di un livello rispetto al menù corrente Conferma valore parametro Premere per almeno 5 secondi Default: attivazione manuale Stand-by Funzione configurabile dall'utente		SET (ENTER) Premere e rilasciare Visualizza eventuali allarmi (se presenti) Accede al menu Stato Macchina Conferma i comandi Premere per almeno 5 secondi Accede al menu di Programmazione

ICONE*

	SET Ridotto / Economy Acceso fisso: risparmio energetico attivo Lampeggiante: set ridotto attivo Spenta: altrimenti		Allarme Acceso fisso: presenza di un allarme Lampeggiante: allarme tacitato Spenta: altrimenti
	Compressore Acceso fisso: compressore attivo Lampeggiante: ritardo, protezione o attivazione bloccata Spenta: altrimenti		Sbrinamento Acceso fisso: sbrinamento attivo Lampeggiante: attivazione manuale o da ingresso digitale Spenta: altrimenti
	Ventole Acceso fisso: ventole attive Spenta: altrimenti		AUX Acceso fisso: uscita AUX attiva e/o luce accesa Lampeggiante: Ciclo Abbattimento attivo
	°C Acceso fisso: visualizzazione a display in °C (dro=0) Spenta: altrimenti		°F Acceso fisso: visualizzazione a display in °F (dro=1) Spenta: altrimenti

(*) Per l'elenco completo dei tasti e delle icone dei singoli terminali, consultare il Manuale Utente.

CONNESSIONI CON TERMINALE UTENTE E DISPLAY REMOTO

Ad ogni RTX 600 /VS può essere connesso un solo terminale KDEPlus, KDWPlus, KDT o KDX incluso un visualizzatore ECPlus per la visualizzazione remota.

CONNESSIONE RTX 600 /VS + KDEPlus + ECPlus

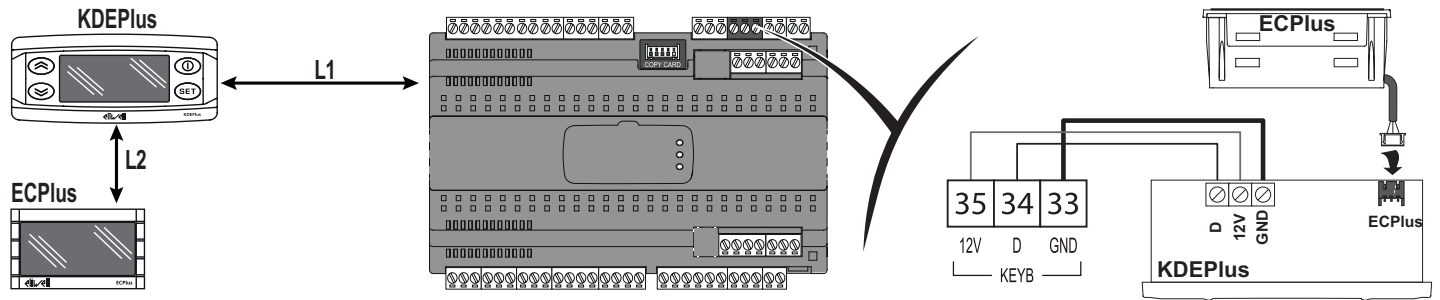

Legenda: L1 = massimo 15 m / 49,21 ft; L2 = massimo 85 m / 278,87 ft

CONNESSIONE RTX 600 /VS + KDWPlus + ECPlus

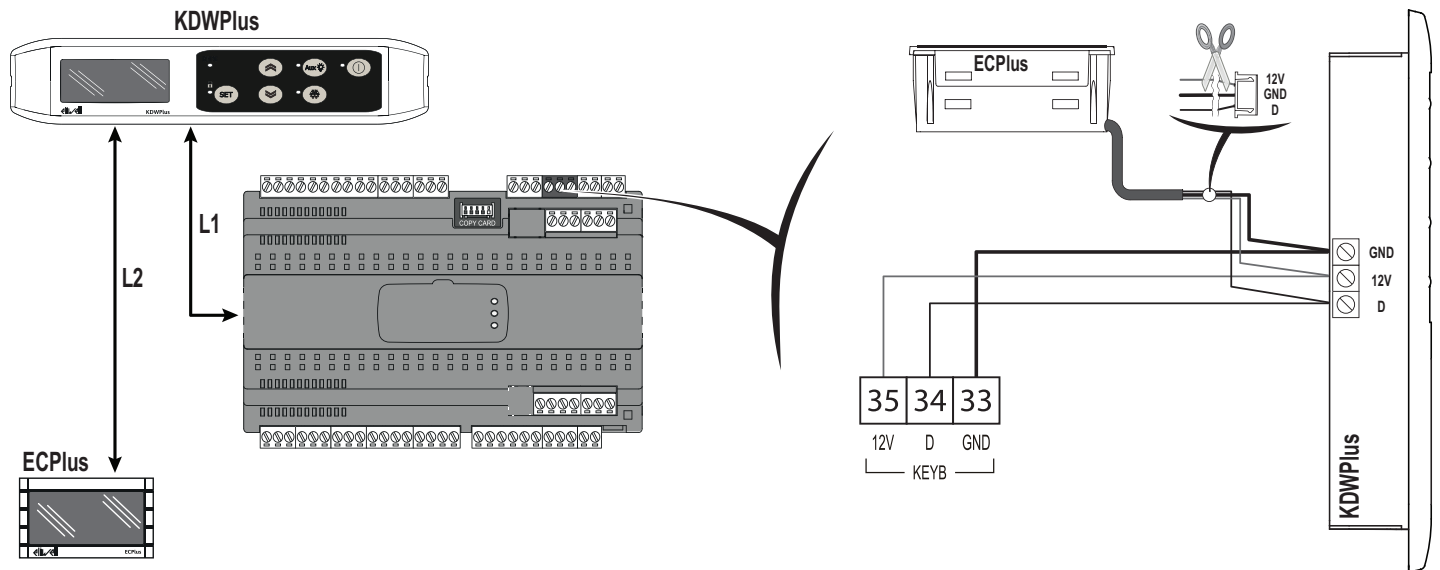

Legenda: L1 = massimo 15 m / 49,21 ft; L2 = massimo 85 m / 278,87 ft.

NOTA: È possibile connettere un visualizzatore ECPlus alla KDWPlus sullo stesso morsetto dove si collega la base.

CONNESSIONE RTX 600 /VS + KDT

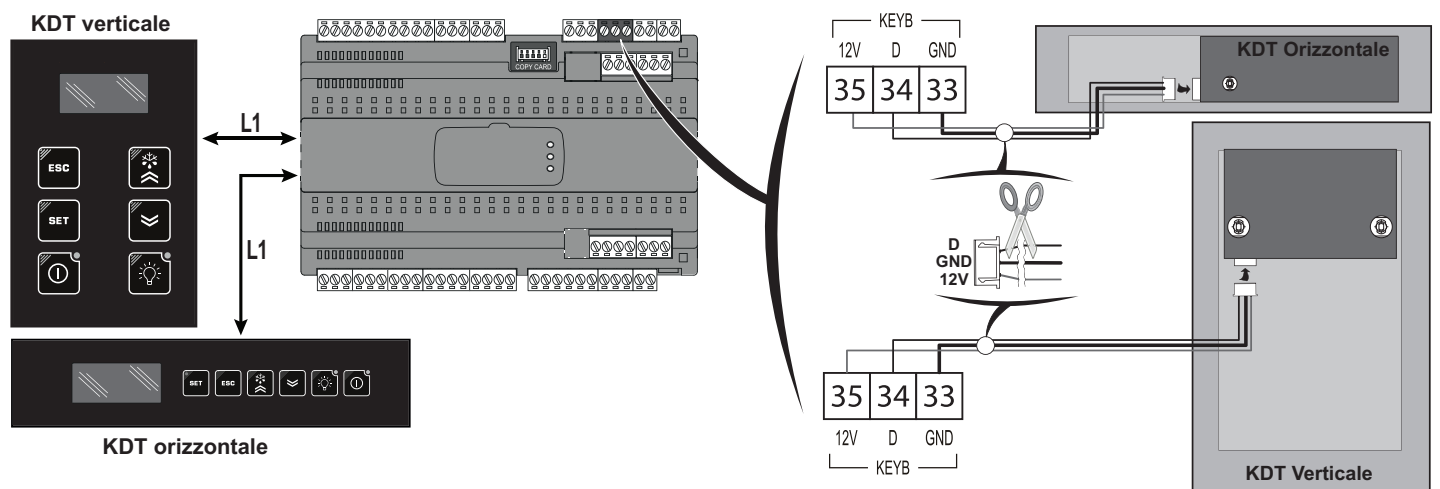

Legenda: L1 = massimo 100 m / 328,08 ft.

CONNESSIONE RTX 600 /VS + KDX

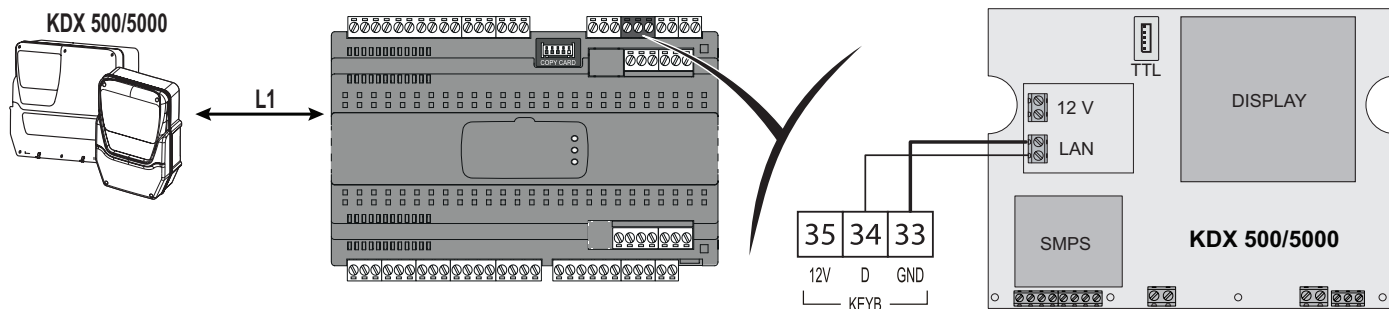

Legenda: L1 = massimo 100 m / 328,08 ft.

CONNESSIONE RTX 600 /VS + ECPlus

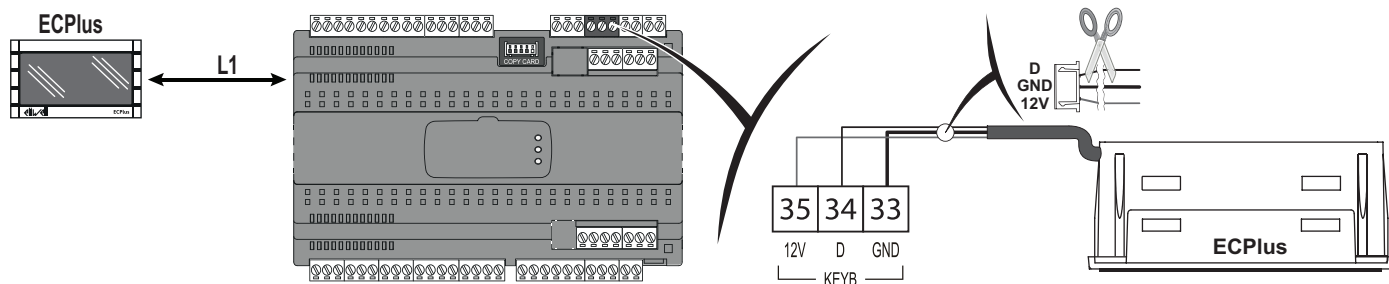

Legenda: L1 = massimo 100 m / 328,08 ft.

RETE LOCALE E DI SUPERVISIONE

È possibile collegare fino a un massimo di 8 strumenti **RTX 600 /VS** in una rete locale Link² e connettere solo un dispositivo alla rete di supervisione Modbus, il quale fungerà da gateway per gli altri dispositivi collegati alla rete locale. La configurazione della Link² avviene utilizzando gli stessi indirizzi del sistema di supervisione.

DEVICE MANAGER

L'**RTX 600 /VS** può interfacciarsi con il software "Device Manager" mediante l'interfaccia DMI. Tale connessione permette la gestione a PC del valore/visibilità dei parametri fissi e di quelli presenti nelle applicazioni predefinite.

DIAGNOSTICA

La condizione di allarme viene sempre segnalata tramite l'icona allarme (☉).
 Per tacitare l'allarme, premere e rilasciare un tasto qualsiasi, l'icona relativa continuerà a lampeggiare.
 Se sono in corso tempi di esclusione allarme (cartella "AL" della Tabella Parametri), l'allarme non viene segnalato.
 Per l'elenco degli allarmi, consultare il Manuale Utente.

RESPONSABILITÀ E RISCHI RESIDUI

La responsabilità di Schneider Electric e Eliwell è limitata all'uso corretto e professionale del prodotto secondo le direttive contenute nel presente e negli altri documenti di supporto, e non è estesa a eventuali danni causati da quanto segue (in via esemplificativa ma non esaustiva):

- installazione/uso diversi da quelli previsti e, in particolare, difformi dalle prescrizioni di sicurezza previste dalle normative e/o date con il presente;
- uso su quadri che non garantiscono adeguata protezione contro la scossa elettrica, l'acqua e la polvere nelle condizioni di montaggio realizzate;
- uso su quadri che permettono l'accesso a parti pericolose senza l'uso di un meccanismo di bloccaggio a chiave o di utensili per accedere allo strumento;
- manomissione e/o alterazione del prodotto;
- installazione/uso in quadri non conformi alle normative vigenti nel paese di installazione del prodotto.

CONDIZIONI D'USO

Uso consentito

Il dispositivo dovrà essere installato e usato secondo le istruzioni fornite ed in particolare, in condizioni normali, non dovranno essere accessibili parti a tensione pericolosa. Il dispositivo dovrà essere adeguatamente protetto dall'acqua e dalla polvere in ordine all'applicazione e dovrà altresì essere accessibile solo con l'uso di un meccanismo di bloccaggio a chiave o di utensili (ad eccezione del frontale). Il dispositivo è idoneo ad essere incorporato in un apparecchio per uso domestico e/o similare nell'ambito della refrigerazione ed è stato verificato sulla base delle norme armonizzate europee di riferimento.

Uso non consentito

Qualsiasi uso diverso da quello consentito è di fatto vietato. Si fa presente che i contatti relè forniti sono di tipo funzionale e sono soggetti a guasto: eventuali dispositivi di protezione previsti dalla normativa di prodotto o suggeriti dal buon senso in ordine a palesi esigenze di sicurezza devono essere realizzati al di fuori del dispositivo.

SMALTIMENTO



Il dispositivo (o il prodotto) deve essere oggetto di raccolta separata in conformità alle vigenti normative locali in materia di smaltimento.

Eliwell Controls s.r.l.

Via dell'Industria, 15 • Z.I. Paludi

32016 Alpago (BL) - ITALY

T: +39 0437 986 111

F: +39 0437 989 066

www.eliwell.com

Supporto Tecnico Clienti:

T: +39 0437 986 300

E: Techsuppeliwell@schneider-electric.com

Vendite:

T: +39 0437 986 100 (Italia)

T: +39 0437 986 200 (altre nazioni)

E: saleseliwell@schneider-electric.com

MADE IN ITALY

RTX 600 /VS DOMINO ZERO • IT
© 2020 Eliwell • Tutti i diritti riservati.